



utopia

# ANTIGUA

MICRO LED TABLE LAMP



Operating Instructions

# ANTIGUA

## MICRO LED TABLE LAMP

LED 2.7K - 4K switchable  
2.2W - DC 3.7V - IP65

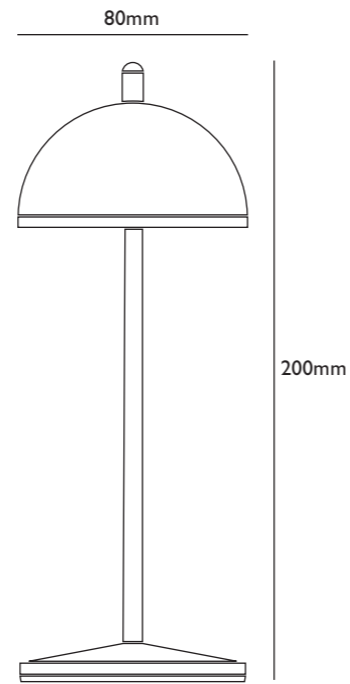

### Product Description

<b>Model</b> Antigua Micro	<b>Application</b> Rechargeable table light	<b>Net Weight</b> 420g	<b>Dimensions</b> 80 x 200mm	<b>Inner Box</b> 120 x 90 x 240mm	<b>Outer Carton</b> 380 x 380 x 260mm	<b>Pcs/Ctn</b> 12
<b>Input Voltage</b> DC3.7V	<b>Power</b> 2.2W	<b>Safety Class</b> CLASS III	<b>Ingress Protection</b> IP65	<b>Beam Angle</b> 100°	<b>Light Source</b> SMD	<b>Luminaire Flux</b> 160 lm
<b>Materials</b> Die-cast aluminium alloy, clear polycarbonate diffuser with optical structure.						

### How to use

This product is made exclusively for lighting purposes. It must not be exposed to heavy mechanical loads or contamination. Please install and use only after thoroughly checking that it is undamaged. Any installation or maintenance must be carried out while the product is turned off. Any alterations to the product, tampering with the product, or failure to comply with the instructions may harm the product and make it hazardous. When fully assembled, the lamp (not including the charging base), reaches an IP65 rating making it ideal for outdoor use. When assembled fully and on top of the charging base it has an IP20 rating which means it is not suitable for outdoor use. All metal and plastic surfaces should be cleaned with a soft dry cloth. Utopia shall not be held liable for any damage caused due to its products being assembled or used in any manner that does not comply with these instructions.

### Battery charger technical data

- Contact charging base : INPUT/OUTPUT 5Vdc -1A; cavo USB 1.2 Mt.
- Charger: INPUT AC100-240V 50/60Hz; OUTPUT 5Vdc -1A.
- This lamp may also be used when connected to the charging base.
- It is advised that only the original provided charging base is used. Alternatively, 1A max chargers can be used.

### Important to know

- The lamps supporting surface should not exceed 15° of tilt or it will fall.
- The provided battery has an overload protection function.
- To preserve the integrity of this battery, we recommend keeping the charging to 20% minimum to 80% maximum; if the lamp is not used regularly it is advised to regularly charge/discharge it.
- Please refer to local laws/guidance for proper disposal/recycling of the battery.

### Table Lamp IP65

Contact Charging Base IP20

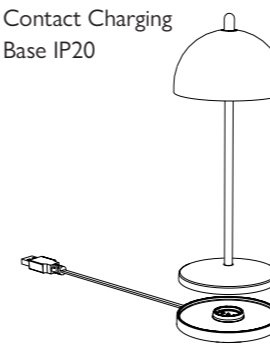

### ON/OFF TOUCH SWITCH

Turn lamp on/off with one touch  
Enjoy the same brightness level as previous use, with a smart brightness level memory system.

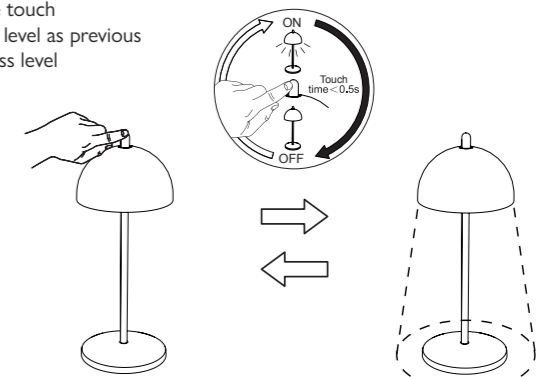

### CCT SWITCH

Only works when the light is on.

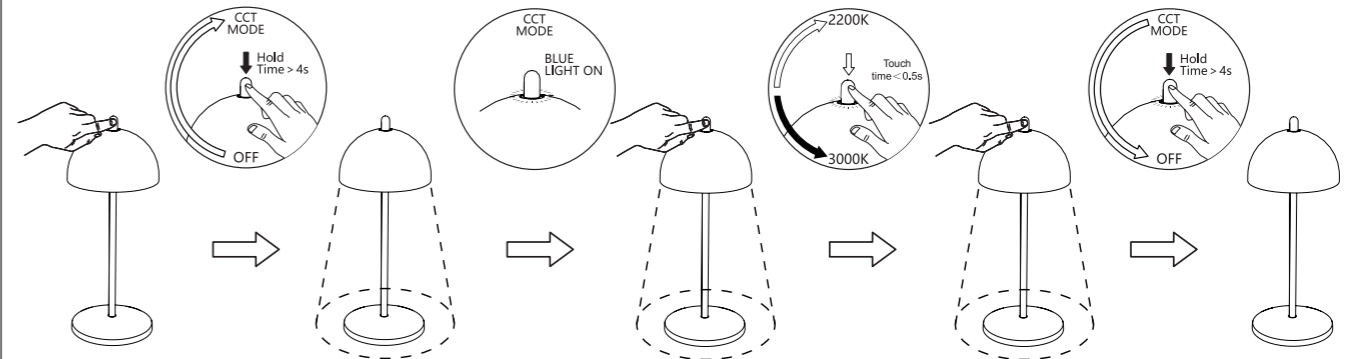

If there is no operation within 10 seconds, the lamp will automatically quit the colour temperature switching mode

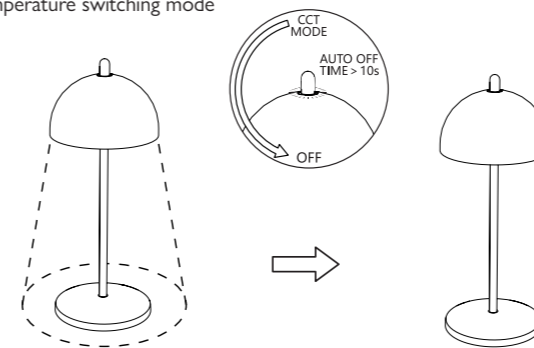

### STEPLESS DIMMER

Only works when the light is on.

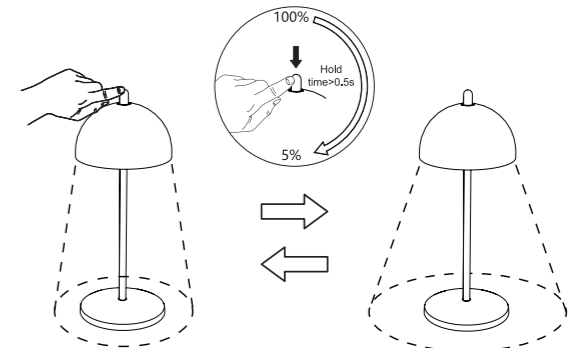

### CHARGE

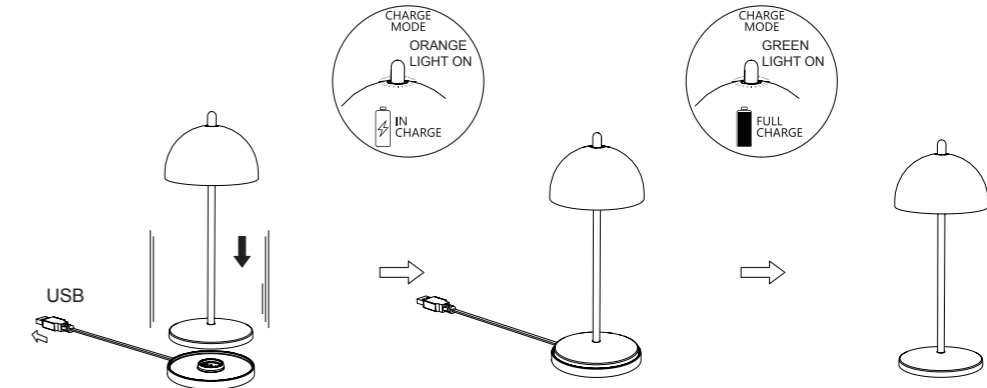



utopia

Head Office & Showroom  
Utopia Tableware  
One Langham Park,  
Mansfield Road,  
Chesterfield, S41 0GG

T. 01246 858800  
E. [info@utopia-tableware.com](mailto:info@utopia-tableware.com)

[www.utopia-tableware.com](http://www.utopia-tableware.com)  
[/utopiatableware](#)  
[@utopiatableware](#)

